

STANDARD SPECIFICATIONS

WORK INCLUDED

The doors will be Series 591 as manufactured by Overhead Door Corporation.

RELATED WORK

Opening preparation, miscellaneous or structural metal work, access panels, finish or field painting, field electrical wiring, wire, conduit, fuses and disconnect switches are in the Scope of Work of other divisions or trades.

SECTIONS

Sections will be roll-formed, hot dipped, galvanized steel exterior no less than .015". Sections will be manufactured by a continuous foamed-in-place polyurethane lamination process resulting in a metal/foam/metal sandwich of homogeneous polyurethane insulation. Sections will have a nominal thickness of 1-5/8" and will incorporate an EPDM rubber thermal break to prevent heat or cold conductivity. Sections will have a shiplap rabbet. INSULATION

Insulation will be a rigid, foamed-in-place, polyurethane core free of CFCs and HCFCs and will be fully encapsulated in nonpermeable materials to prevent loss of thermal efficiency over time. The insulation will have an R-Value of 14.86, U-Value of .067 - calculated values based on certified test data.

AIR INFILTRATION

All doors will be constructed with an air infiltration rating of .08 cfm per square foot of door at 15 mph and .13 cfm per square foot of door at 25 mph. (ASTM-E-283-73)

END STILES

End stiles will be 16 gauge steel.

HARDWARE

Hinges and fixtures will be galvanized steel.

Full-floating ball-bearing rollers will have hardened steel races. Roller sizes will be adequate for design requirements and limitations.

WEATHERSTRIP

Bottom weatherstrip will be EPDM rubber bulb-type strip.

FINISH

Finish will be 2 coat baked-on polyester with a white interior and white exterior.

INSTALLATION

Install the doors in accordance with Overhead Door Corporation instructions and standards, using an authorized Overhead Door Corporation distributor.

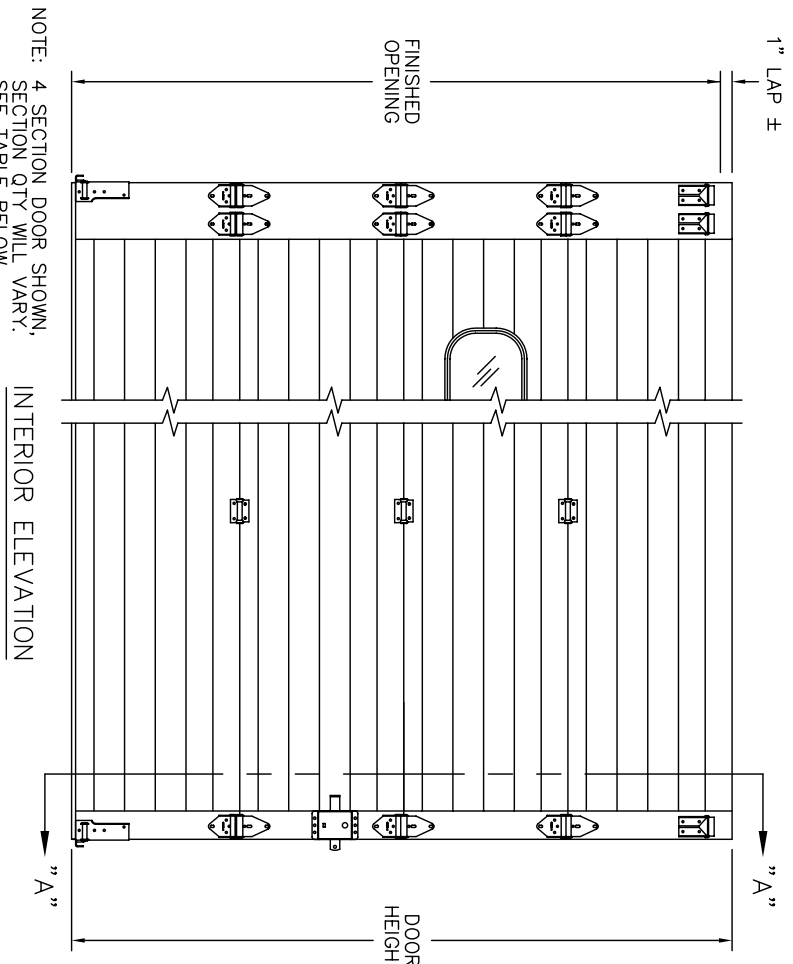
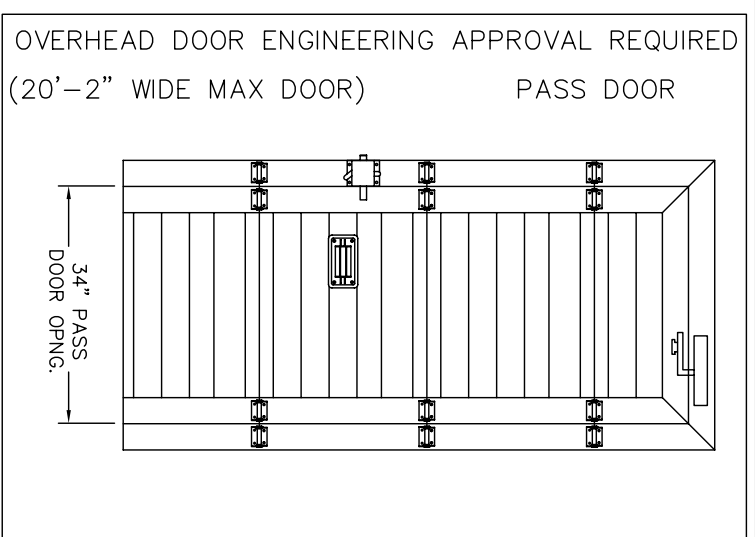

NOTE: 4 SECTION DOOR SHOWN, SECTION QTY WILL VARY, SEE TABLE BELOW.

END STILE TYPE:

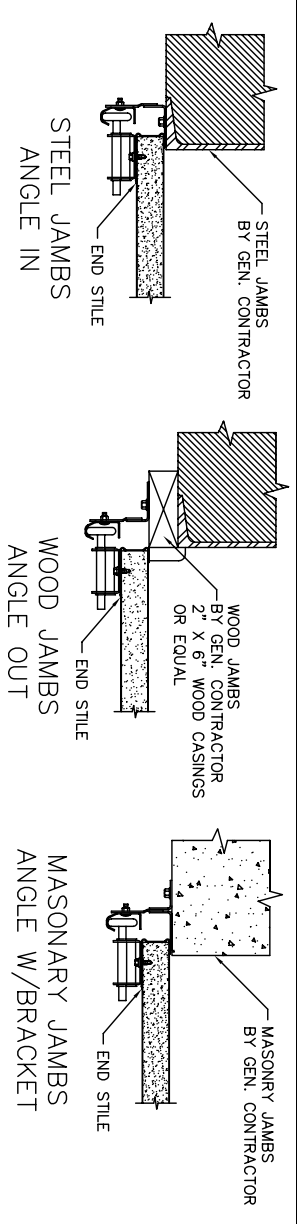

TRACK STYLE:

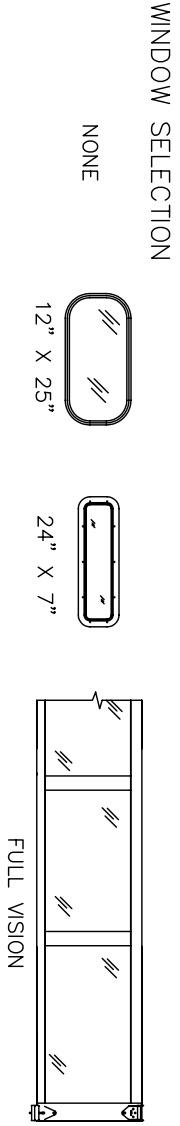

LOCATION AND NUMBER :

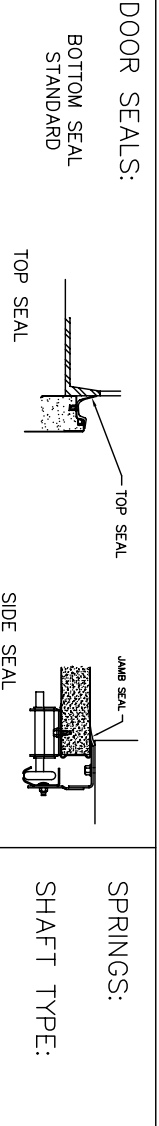

SPRINGS:
SHAFT TYPE:

EXHAUST PORT PREP

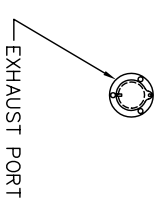

DRAW BAR PREP

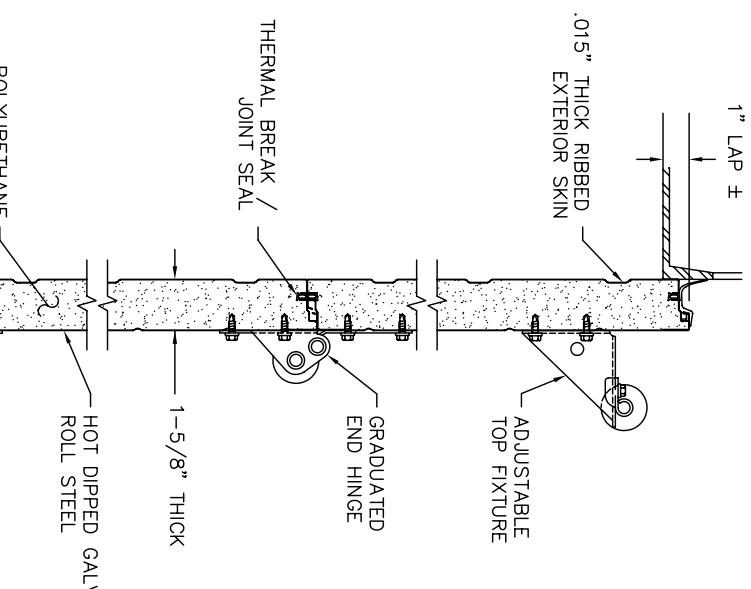
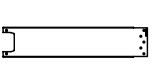

SECTION "A - A"

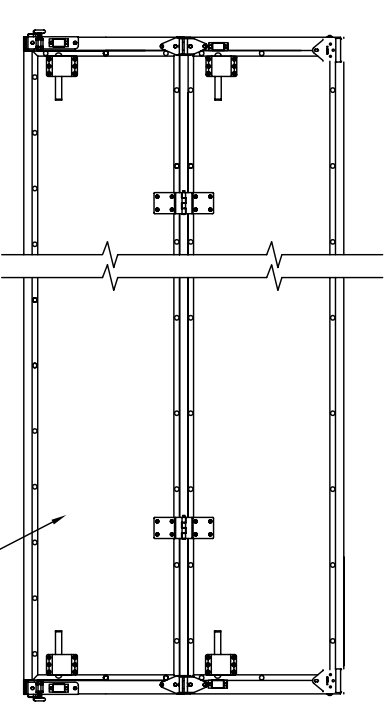

ENGINEERING APPROVAL REQUIRED

KNOCK & LOCK™ SECTIONS
Bottom two sections automatically reset eliminating downtime. Rugged Valtra brand interior skin is highly abrasion resistant and virtually puncture-proof. Two-pound density two-inch thick foam core absorbs and disperses impact energy.

OVERHEAD DOOR MARK	QTY	OPENING SIZE		DOOR SIZE		LIFT TYPE	SECTIONS HIGH	EXTERIOR COLOR
		WIDTH	HEIGHT	WIDTH	HEIGHT			

ADDED OPTIONS : (PER DOOR)

ADDED OPTIONS : (PER DOOR)

PROJECT	591 THERMACORE SERIES	
ARCHITECT		
CONTRACTOR		
DISTRIBUTOR		
PLANT		
DWG. NO.	DATE:	
SHEET	BY:	

